



OpreX™ Field Instruments

# ROTAMASS Total Insight

Coriolis Mass Flowmeter  
Flow, density and  
concentration measurement



# Multivariable measurement with Coriolis flowmeter



Rotamass TI is the Yokogawa Coriolis mass flowmeter providing very high accuracy for measuring liquids and gases.

From the direct mass flow, density, temperature measurements, with Rotamass TI you can calculate:

- volume flow at operating or reference conditions
- density at reference conditions
- concentration measurements of mixable or unmixable fluids.

With additional measurement input Rotamass TI can calculate fluid viscosity for Newtonian liquids or energy-heating value for gas measurement.

# Total Insight throughout the entire product lifecycle

The Rotamass TI philosophy gives total insight throughout the whole lifecycle of your flowmeter and of your process application.

Combining reliable technology with superior field knowledge, Yokogawa offers added value and supports the user in every phase of the product lifecycle and application.

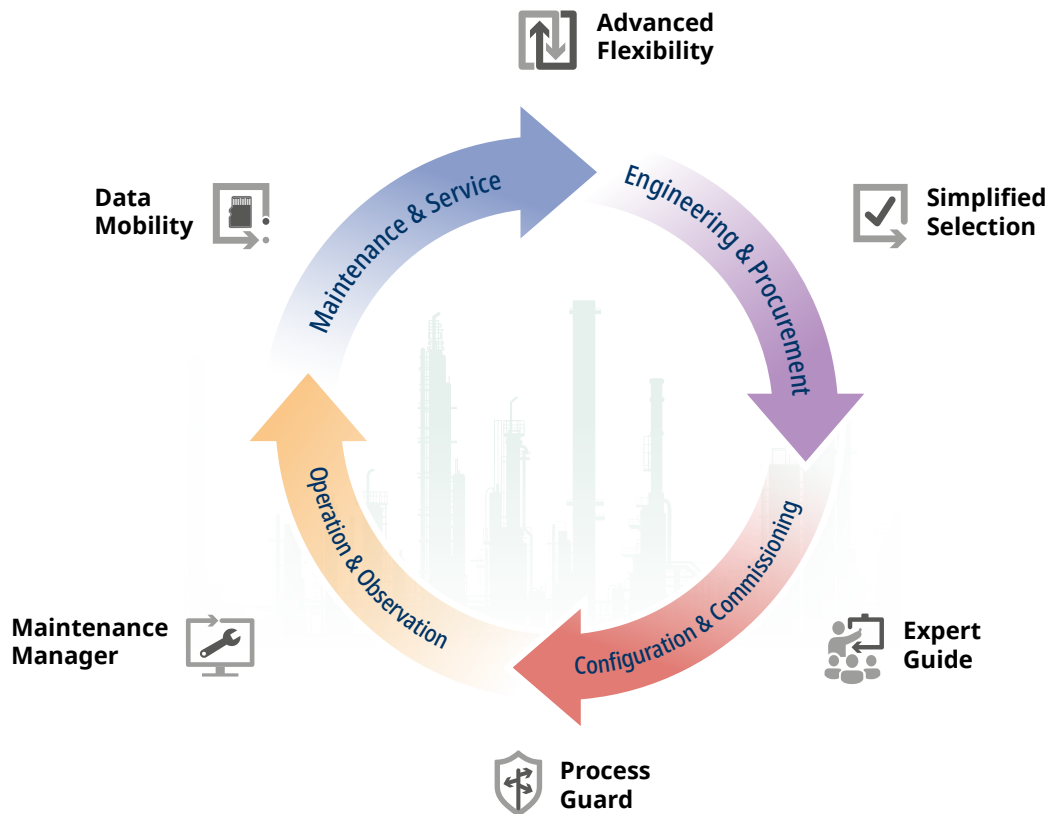

## Product and application lifecycle

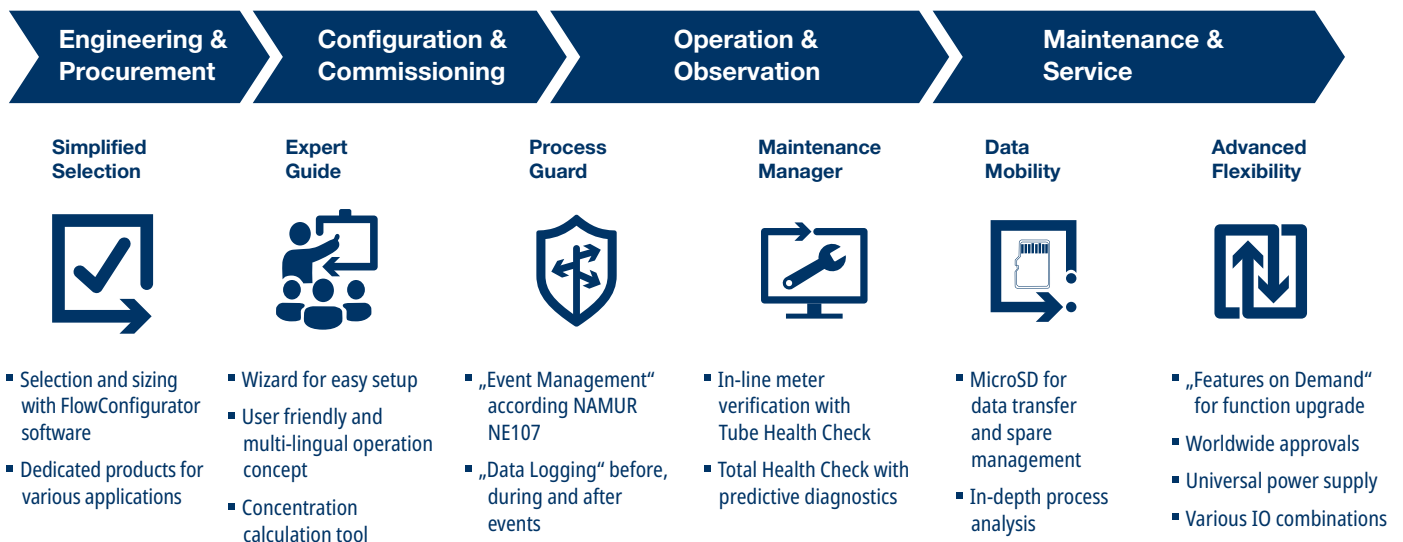

# SELECTION GUIDE

Simplified Selection



**ROTAMASS**  
nano

**ROTAMASS**  
prime

**ROTAMASS**  
hygienic



Flow range

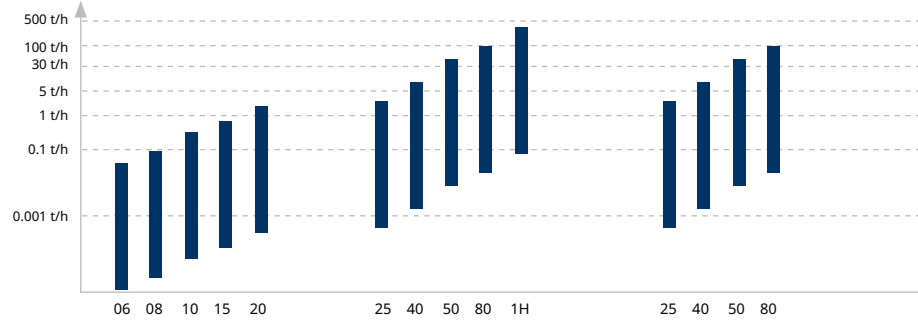

Meter size

Product Line	ROTAMASS Nano	ROTAMASS Prime	ROTAMASS Hygienic
<b>Liquid process fluids</b>			
Liquids in general	✓✓	✓✓	✓✓
Aggressive liquids	✓	-	-
High viscous fluids	✓	✓✓	✓✓
<b>Gaseous process fluids</b>			
Gases in general	✓	✓✓	✓
Low density gases	✓	✓✓	✓✓
<b>Mixed process fluids</b>			
Unmixable or mixable liquids	✓✓	✓✓	✓✓
Liquids with entrained gas	✓✓	✓✓	✓✓
<b>Process conditions</b>			
Process temperature	-50 to +260 °C -58 to +500 °F	-70 to +200 °C -94 to +392 °F	-70 to +140 °C -94 to +284 °F
Process pressure up to	285 bar or 460 bar <sup>1)</sup> 4183 psi or 6672 psi <sup>1)</sup>	100 bar 1450 psi	40 bar 580 psi
Line sizes	DN15 to DN40 1/4 in. to 1 1/2 in.	DN15 to DN125 3/8 in. to 5 in.	DN25 to DN80 1 in. to 3 in.
<b>Accuracy</b>			
Mass flow for liquids up to	+/- 0.1 %	+/- 0.1 %	+/- 0.1 %
Mass flow for gas up to	+/- 0.35 %	+/- 0.35 %	+/- 0.35 %
Density for liquids up to	+/- 0.5 g/l	+/- 0.5 g/l	+/- 0.5 g/l
Turndown flat accuracy	✓	✓✓	✓✓
<b>Materials and process connections</b>			
Material of wetted parts	Alloy C-22/2.4602 & 316L/1.4404	316L/1.4404	316L/1.4404
Flange process connections	EN, ASME, JPI, JIS	EN, ASME, JPI, JIS	-
Threaded process connections	G, NPT	G, NPT	DIN11851, SMS1145
Clamp process connections	DIN32676	-	DIN32676, JIS/ISO2852
<b>Sensor design</b>			
Insulation and heat tracing options	✓✓	-	-
Rupture disk	✓ <sup>1)</sup>	-	-
Customer & NAMUR face-to-face length	✓✓	✓✓	-
<b>Approvals / Certificates</b>			
3-A or EHEDG application	-	-	✓✓
Marine application	✓✓	✓✓	✓✓
Functional Safety	SIL 2 (SIL3)		
Hazardous area approvals	IECEX, ATEX, FM (USA/Canada), NEPSI, INMETRO, PESO, EAC Ex, Taiwan Safety Label, Korea Ex, Japan Ex, ECAS Ex, Ukraine Ex		

✓✓ supported

✓ supported under certain conditions

- not supported

<sup>1)</sup> available on demand

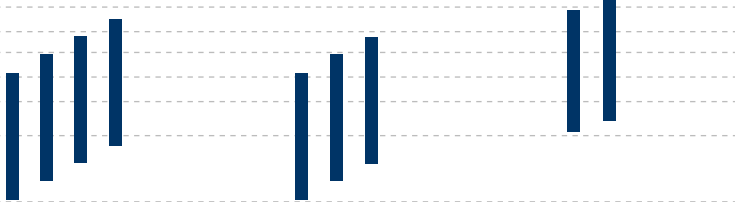

34 36 38 39

34 36 38

1F 2H

ROTAMASS Supreme	ROTAMASS Intense	ROTAMASS Giga
✓✓	✓✓	✓✓
✓✓	✓✓	✓
✓	✓	✓
✓	✓	✓✓
✓	✓	✓
✓✓	✓✓	✓✓
✓✓	✓✓	✓
-196 to +350 °C -321 to +662 °F	-70 to +150 °C -94 to +302 °F	-70 to +350 °C -94 to +662 °F
100 bar or 250 bar <sup>1)</sup> 1450 psi or 3626 psi <sup>1)</sup>	260 bar or 360 bar <sup>1)</sup> 3771 psi or 5221 psi <sup>1)</sup>	100 bar or 180 bar <sup>1)</sup> 1450 psi or 2610 psi <sup>1)</sup>
DN15 to DN125 3/8 in. to 5 in.	- 3/8 in. to 2 in.	DN100 to DN200 4 in. to 8 in.
+/- 0.1 %	+/- 0.1 %	+/- 0.1 %
+/- 0.35 %	+/- 0.35 %	+/- 0.35 %
+/- 0.5 g/l	+/- 0.5 g/l	+/- 1.0 g/l
✓	✓	-
316L/1.4404 or alloy C-22/2.4602 or 304/1.4301 <sup>1)</sup>	316L/1.4404 or alloy C-22/2.4602 or 304/1.4301 <sup>1)</sup>	316L/1.4404 or alloy C-22/2.4602
EN, ASME, JPI, JIS	ASME	EN, ASME, JIS
G, NPT	G, NPT	-
DIN32676, JIS/ISO2852	-	-
✓✓	-	✓✓
✓✓	✓✓	✓✓
✓✓	-	✓
✓✓	-	-
✓✓	✓✓	✓
SIL 2 (SIL3)		
IECEX, ATEX, FM (USA/Canada), NEPSI, INMETRO, PESO, EAC Ex, Taiwan Safety Label, Korea Ex, Japan Ex, ECAS Ex, Ukraine Ex		

## FC FlowConfigurator

Selecting the flowmeter that best meets your specific needs and requirements.

<http://www.flowconfigurator.com>

## ROTAMASS TI with Essential or Ultimate Transmitter

The Rotamass TI product family has a common and unified transmitter platform consisting of Essential and Ultimate transmitter. Both options are offering:

- Multi-lingual wizard for easy setup
- Event Management according NAMUR NE107
- MicroSD card for easy data transfer and spare management
- Wide range of I/O combinations
- Universal power supply
- Tube Health Check for in-line meter verification
- HART or Modbus communication
- Ultra low copper Aluminium or stainless steel transmitter housing
- NAMUR NE95 compliant

### Beyond that the Ultimate transmitter provides:

- In-line concentration measurement
- Net Oil Computing acc. API
- Dynamic Pressure Compensation
- Batching function
- Viscosity function
- Profibus PA or Foundation Fieldbus communication
- Features on Demand for function upgrade



# Predictive Maintenance with Total Health Check

The intention of process automation is to meet targets like accuracy, efficiency, flexibility and reliability in order to eliminate costs and achieve safety.

With Total Health Check, Rotamass TI offers an effective maintenance and diagnostic tool for a complete meter verification without disturbing your process.

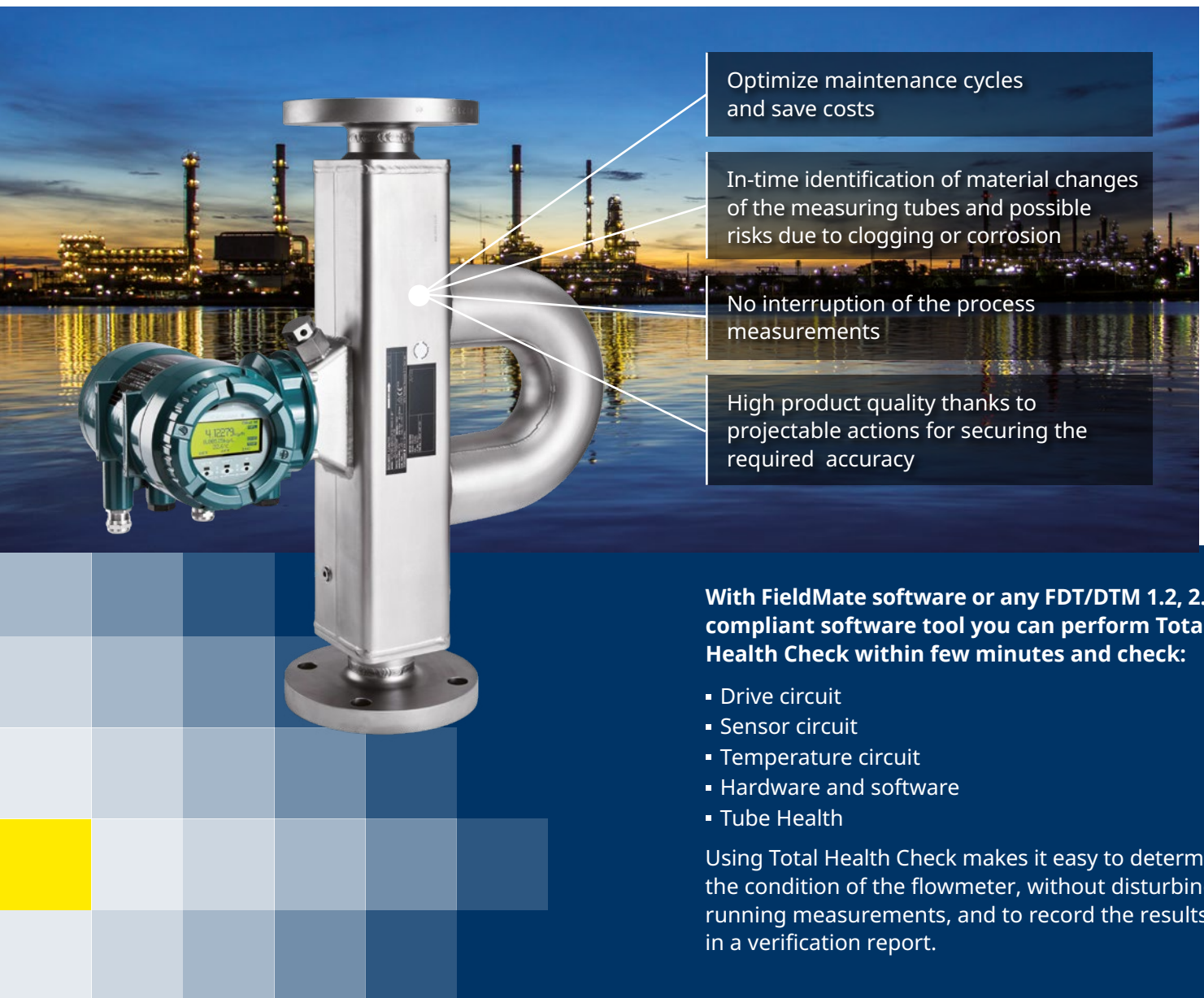

Optimize maintenance cycles and save costs

In-time identification of material changes of the measuring tubes and possible risks due to clogging or corrosion

No interruption of the process measurements

High product quality thanks to projectable actions for securing the required accuracy

**With FieldMate software or any FDT/DTM 1.2, 2.0+ compliant software tool you can perform Total Health Check within few minutes and check:**

- Drive circuit
- Sensor circuit
- Temperature circuit
- Hardware and software
- Tube Health

Using Total Health Check makes it easy to determine the condition of the flowmeter, without disturbing running measurements, and to record the results in a verification report.

## Tube Health Check

**An important element of the Total Health Check meter verification is the Tube Health Check.**

This unique function detects stiffness changes of the measuring tubes, which can occur due to corrosion, abrasion or clogging.

This is of particular importance, because changed measuring tube stiffness is directly affecting the mass flow measurement.

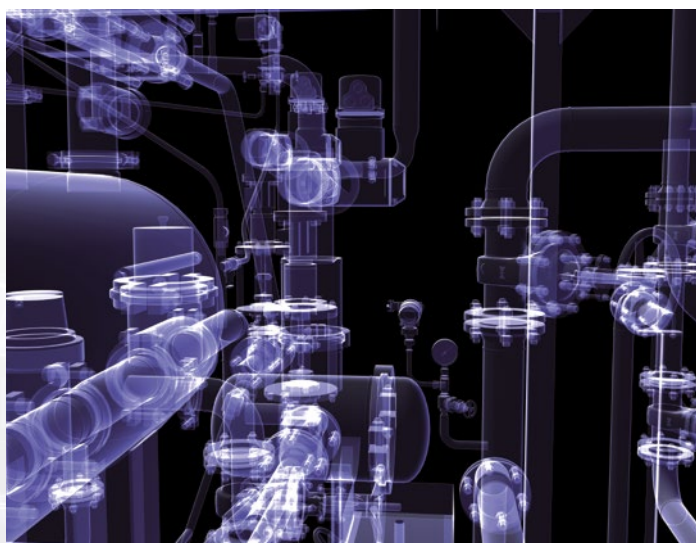

**The Tube Health Check is an in-line verification and can be individually adapted to your process conditions:**

- Frequency of checks (single or automatic test with predefined intervals)
- Definition of alarm levels
- Yokogawa's FieldMate using DTM delivers a complete report and indicates a clear verification result



*With the help of trend analysis of the Tube Health Check results you can improve maintenance schedules and avoid unnecessary service activities.*

*Beyond that the collected data can be used to draw new conclusions about the process itself.*



# Safe and reliable operation with ROTAMASS TI

The process of measuring mass or volume flow of liquids, gases and mixtures is often affected by demanding and changing process conditions.

In your process you may face fluctuations of density, temperature, pressure and environmental conditions.

The flowmeters experience stress due to pipe vibrations, torsion, elongation or tension.

In order to compensate changing process conditions, provide stable measuring results and maintain high accuracy in a reliable way Rotamass TI is equipped with the most robust design.



Optimal decoupling of the core measuring element against external stresses and vibrations



Compensation of fluctuations of process conditions by well balanced dual bent tubes



The quality of our thick measuring tubes results in a long lifetime and low process pressure effect



Increased safety by completely welded and inert gas tight sensor housing, with secondary containment up to 120 bar.

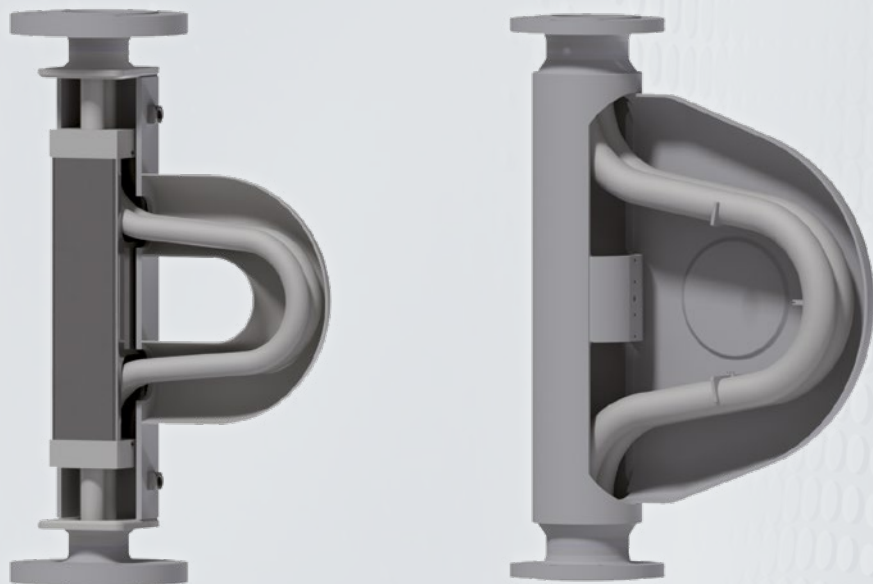





**Hastelloy C** variant of wetted parts material for increased resistance to aggressive fluids like strong acid, oxidizer or to reach higher pressure ratings.



Industry approved **rupture disc** and **dual seals**



Specific design of sensor components for usage in **applications with low temperature -196 °C (-321 °F) for cryogenic fluids or very high temperature up to 350 °C (662 °F)**



**Supported by robust and durable sensor design, our factory-fitted insulation and heat tracing** solutions offer perfect insulation, continuous heating along the entire flow path and purging of the heating fluid. This is enabling to handle high temperature, viscous process fluids or molten fluids like sulfur.



Having a **low pressure loss design by short tube paths and large tube diameters**, our flowmeters contribute to energy-saving operation and reduction of initial cost



Space-saving installation thanks to a compact construction with **short face-to-face length**



# ROTAMASS TI offers high flexibility for your individual application



- Thanks to its **universal power** supply Rotamass TI is ready to be effortlessly installed all over the world
- The **wide range of I/O** combinations allows an individual configuration specific to your system
- All product families can be combined with **Essential and Ultimate** transmitter:
  - ✓ Essential transmitter for general purpose applications
  - ✓ Ultimate transmitter for demanding and critical applications
- A wide range of **standard process connections** is instantly available for the entire Rotamass TI product portfolio allowing installation without adapter
- The **short face-to-face length** of our Coriolis flowmeter can be combined with customer specific installation length options



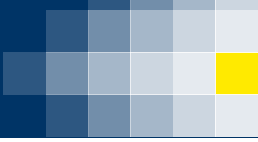

### Features on Demand

Market requirements and process conditions are changing. Features on Demand (FOD) contain valuable functions which can be activated at any time, even after installation and anywhere in the world:

- Concentration measurement functions, Net Oil Computing function
- Batching function
- Viscosity function
- Function for measurement of heat quantity
- Tube Health Check

### Dynamic Pressure Compensation

For applications with fluctuations in pressure a dynamic compensation is important to keep accurate and reliable mass flow measurement or gas volume measurement based on density calculation.

With Rotamass TI and the Dynamic Pressure Compensation function you can benefit from continuous and highly accurate results.

*Markets and process conditions are changing...*

*...and ROTAMASS TI will go along with this change.*



## It's all about the mixture

A lot of processes handle different substances within mixtures. To ensure a constant product quality it can be important to measure not only the quantity or volume, but also the concentration of the process fluid.

Rotamass TI combines mass flow measurement with an online and user-optimized Concentration Measurement function for suspensions, emulsions and solutions.

Pre-installed data sets support a convenient configuration for many different process fluids and can be adapted individually to the process characteristics.

As concentration measurements are highly reliant on temperature and density, Rotamass TI combines a precise coupled temperature measurement with different density calibration options. This allows high accurate and most reliable results.

Being ordered together with the device or activated later as "Feature on Demand" the Rotamass TI Concentration Measurement function is easy to configure and to adapt to maintain accurate measurements, when the concentration ranges are changing.



Many different process fluids



High density and temperature accuracy



Securing high product quality

## Two variants of measurement

### Standard Concentration Measurement for unmixable fluids

Standard concentration measurement is typically used for non-interacting liquids, e.g.:

- Oil-water-emulsions
- Solid phases in suspensions
- Weak salt solutions

The concentration of each component will be computed from the ratios of their mass densities.

Net Oil Computing function provides real-time measurements of net oil and water cut based on "API" (American Petroleum Institute) according API MPMS Chapter 11.1.

### Advanced Concentration Measurement for mixable solutions

The Advanced concentration measurement functions are recommended for more complex applications, such as for liquids that interact:

- Alcohol solutions
- Highly concentrated saltwater solutions
- Sugar in liquid solutions
- Ammonia in water
- Ethanol in water
- Glycol in water
- Chlorine in water

Density over temperature dependency is established for each product and will be programmed as density temperature coefficient for your application.

Up to 4 pre-installed data sets are available for various solutions.



## ROTAMASS TI Concentration Calculation Tool

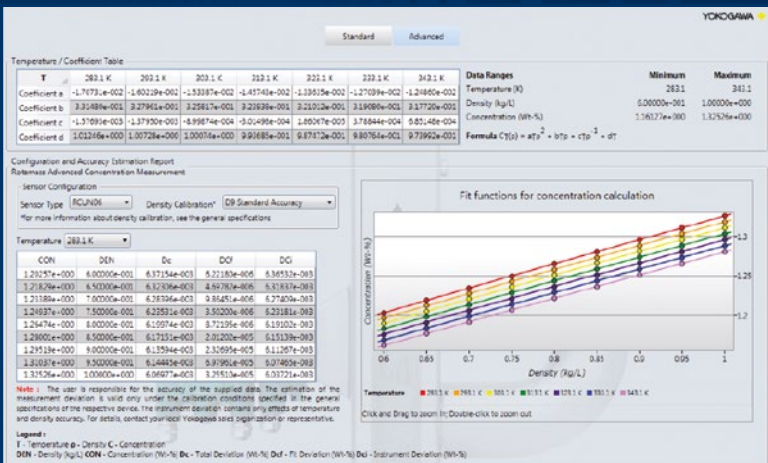

You can make use of the tool to:

- Determine whether you need to install a standard or advanced concentration function on your Coriolis mass flowmeter
- Calculate coefficients of the concentration of a substance
- Determine the accuracy of the calculated concentration of the substance or its components
- Export and import of concentration parameters

*The ROTAMASS TI Concentration Calculation Tool offers great support during the configuration of the Standard and Advanced Concentration functions.*



# Uninterrupted and reliable measurements in entrained gas applications

As soon as a process fluid consists of liquid and gas, it is called a two-phase flow or entrained gas.

The occurrence of gas bubbles in a liquid is often not intended, but can not be avoided in some cases, e.g.

- Oil production process with mixture of oil, water and gas
- Liquified gas (cryogenic fluids)
- Processes in the Chemical industry like heating and mass transfer between gas and liquid in chemical reactors
- Unloading processes of different raw materials out of tanks

Due to their measuring principle Coriolis mass flowmeters are sensitive to two-phase fluids.

Sensitive means that they can produce an incorrect mass flow reading or in worst case the measurement can be stopped.



*Even under high aeration conditions  
ROTAMASS TI delivers uninterrupted  
and repeatable mass flow measurement.*



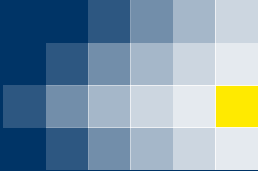

## Designed for gas content compensation:



### Short tube path

In order to reduce the damping effect, caused by the two-phase media, our Coriolis flowmeters have a short tube path.

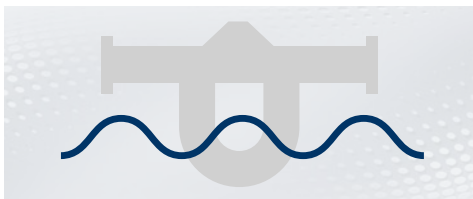

### Low resonance frequency

The damping effect is strongly dependent on the resonance frequency. A low resonance frequency helps to keep the effect small.



### High Power Management

Rotamass TI Smart Power Management compensates the energy deficit by increasing the drive gain in case of entrained gas.

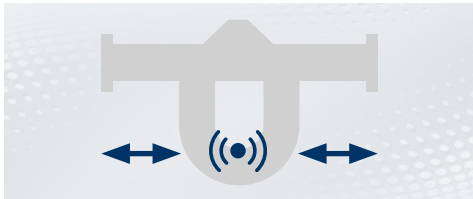

### High sensitivity of DSP

A high sensitivity of the Digital Signal Processor (DSP) keeps the flowmeter working even at small amplitudes.

## Slug detection with ROTAMASS TI

Slug flow occurs when the content of air bubbles is significant. The power increase can be detected by continuously monitoring the drive gain.

Once you defined the slug criteria and set in the parameter, in case of slug flow an alarm will be triggered and the mass flow output value can be held at the last measured value, or at averaged values before the slug event occurred, in order to have better controllability.



# Flexible solution for unmixable or mixable fluids



Mixtures are present, when different substances are not reacting together, but building suspensions, slurries or emulsions which can be found typically in Food & Beverage, Pulp & Paper as well as in the Chemical or Oil industries.

A correct ratio of ingredients is decisive for the final product quality. The concentration or quality of the delivered raw material is unknown and need to be checked before bringing the material into the successive production steps.

With mixable solutions, an in-line concentration measurement of the diluted amount of sugar, alcohol or chemical product in water, will bring operational efficiency compared to time-delayed laboratory measurements.

Rotamass TI combines high precise temperature and density measurements with programmable or pre-set configurations for accurate concentration calculation.

## Flue gas desulfurization in the Power Generation industry

In coal fired Power Generation plants flue gas has to be desulfurized before leaving the chimney. Lime slurry is sprayed into the flue gas, sulfur dioxide (SO<sub>2</sub>) is getting absorbed and turned into gypsum. With density measurement of Rotamass TI the lime slurry concentration is controlled.

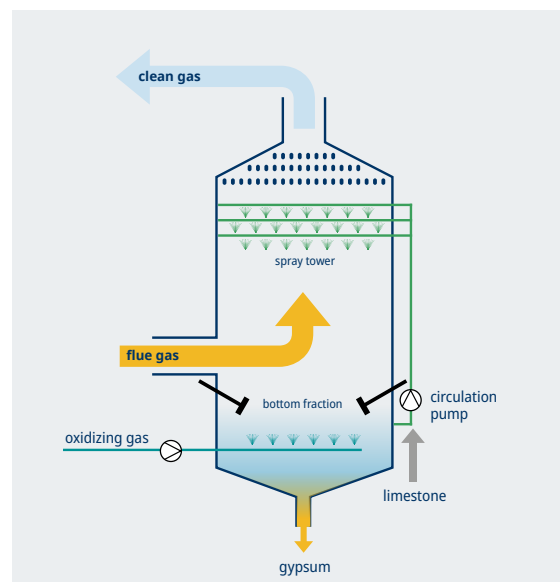

### Product Highlights

- Superior density measurement
- Integrated temperature tables
- Thick measuring tubes against abrasion
- Wetted parts in Hastelloy C with high chemical resistance



Rotamass Supreme

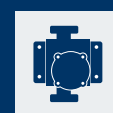

Rotamass Nano



Rotamass Intense



### Distillation of plant extracts in the Pharma, Food & Beverage industry

One way to extract plant fragrances carefully is distillation, producing a mixture of vegetable oil and water. An accurate concentration measurement of vegetable oil in water reduces the energy consumption and total cost of the distillation process. Depending on the results of the concentration measurement with Rotamass TI, the amount of steam, which is used to heat the fresh plants, is optimized.

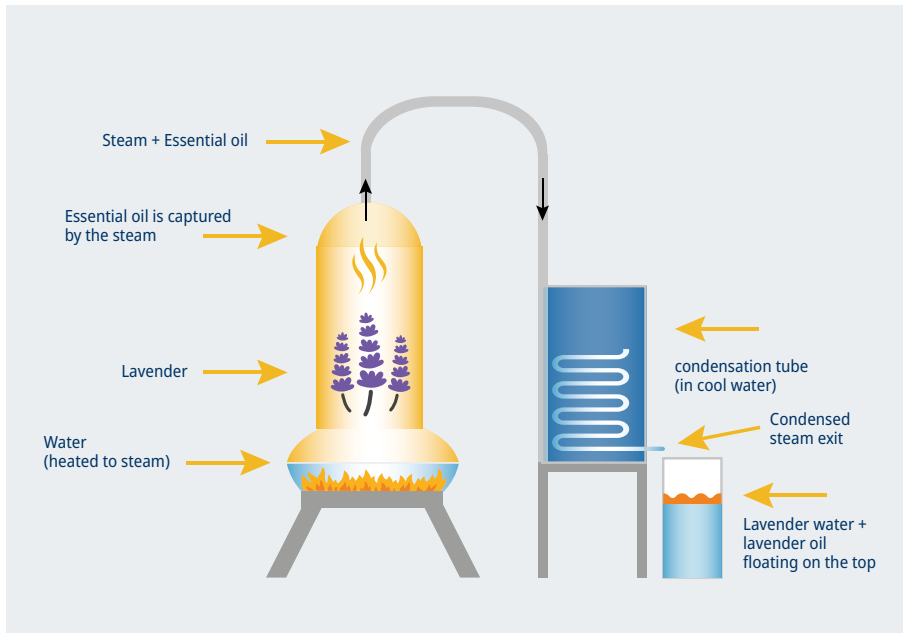

**Product Highlights**

- Excellent density accuracy
- Concentration Calculation Tool
- Self-draining and hygienic design
- 3-A and EHEDG approval

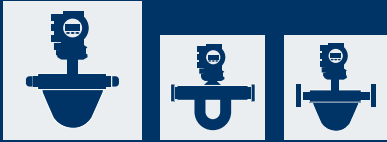

Rotamass Hygienic      Rotamass Supreme      Rotamass Prime

### Net Oil Computing in the upstream oil production

Separators are used in the process of oil exploration, to part the crude oil emulsion into the different phases of water, oil and gas. In order to determine the produced net oil and water cut amounts (in mass or in volume at reference conditions), the Rotamass TI is installed at the oil leg output of the production separator, using the Net Oil Computing function according to API (American Petroleum Institute).

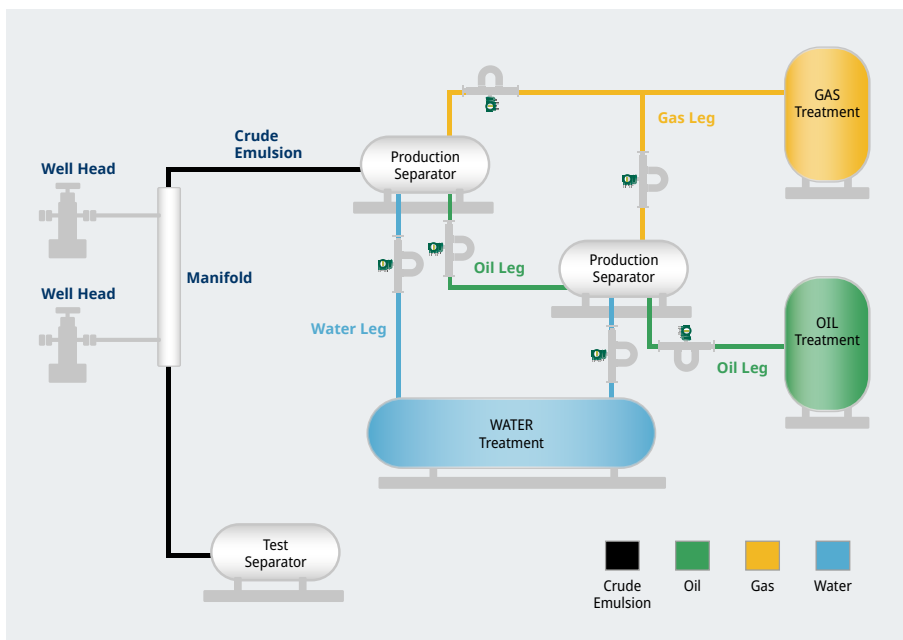

**Product Highlights**

- Integrated Net Oil Computing & Water Cut calculations acc. API
- Optional superior density measurement
- Gas Void Fraction (GVF) measurement
- Compliant to upstream industry requirements



Rotamass Supreme      Rotamass Intense      Rotamass Prime

## Observation and adjustment of important fluid cycles



Resource conservation, environmental protection but also efficiency and security aspects require a continuous monitoring and reporting of critical process parameters.

Coriolis mass flowmeters are not only used for measuring the mass flow, but also for detecting changes in the process in order to perform a proactive operation.

Equipped with function like “Event Management” and “Data Logging” our Rotamass Total Insight product

family is able to trace variances and generate alarms or activate pre-defined functions. The record of relevant data before, during and after the event enables process analysis.

Good examples for those monitoring tasks can be found in the Marine or in the Power industry, when fuel consumption needs to be determined or a heating system must be activated to keep the oil viscosity at a certain level.

### Oil viscosity control in the Marine industry

Controlling viscosity for fuel oil on ships is important to ensure correct processing and injection. In combination with pressure transmitters Rotamass TI provides online viscosity measurement. The Viscosity function returns a reference value used to activate a heating system through an external controller.

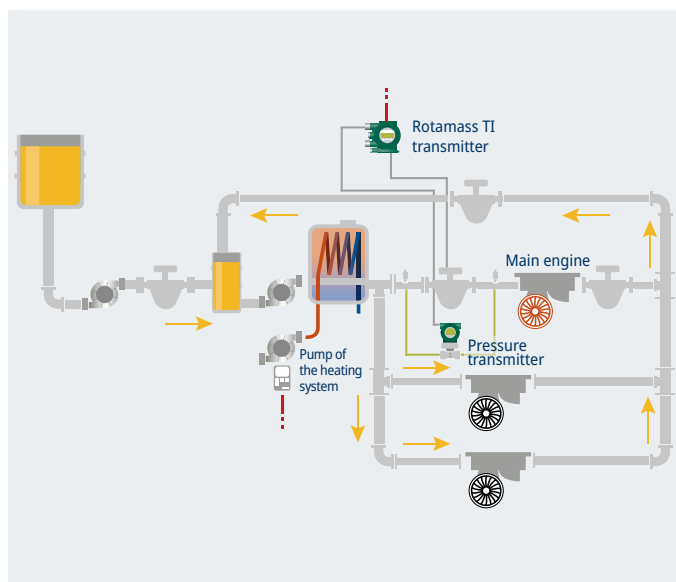

### Product Highlights

- Viscosity function
- Robust design for harsh conditions
- DNV GL type approval
- Different marine cable length options



Rotamass Prime



Rotamass Supreme

### Predictive maintenance for high pressure valves

Huge savings can be obtained if the flow of hydraulic fluid in servo loops is continuously monitored. Furthermore, predictive maintenance helps to protect the servo valves from damage.

However, due to high pressure, entrained air, moisture and contamination in the servo system, the measurement is challenging for a flowmeter. In this application Rotamass TI provides high accuracy, reliability and assures that the circulating oil systems supply a continuous, regulated flow to the critical parts.

Condition of the individual servo bushing is monitored, and complete process is automatized with the help of Data Logging and Event Management.

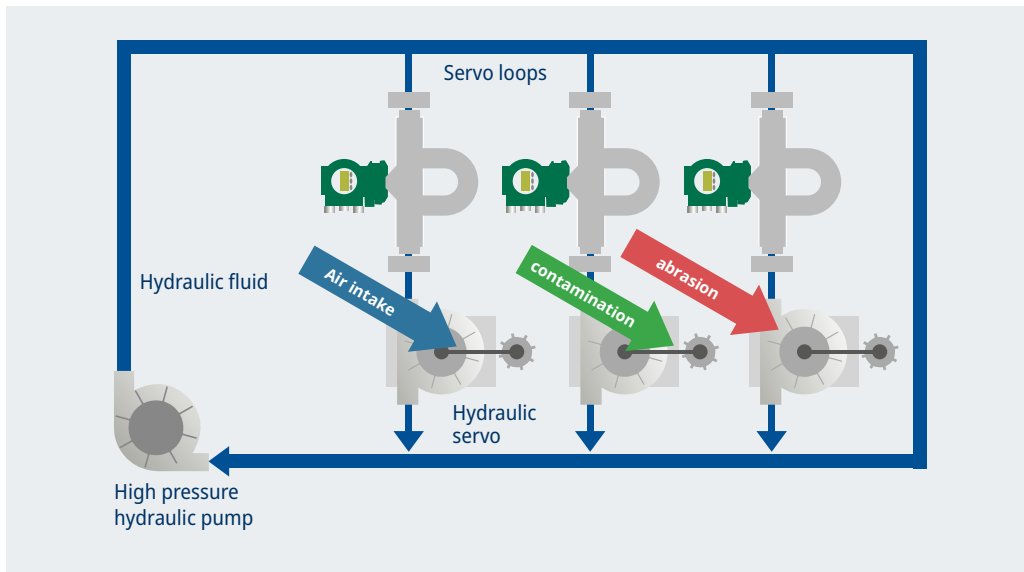

**Product Highlights**

- Capability to handle entrained gas
- Absorption of external stresses
- Heavy wall measuring tubes
- Process guard



Rotamass Intense



Rotamass Nano

### Fuel consumption management

Emission reduction is key driver in Marine industry. As fuels are contributing most onto cost and emissions, monitoring of fuel consumption is required. Coriolis flowmeters provide most accurate measurement and master challenging conditions onboard. Installed in a fuel system Rotamass TI will measure the net amount of consumed fuel oil, no matter if HFO, MDO/MGO, LSMGO, and others are used.

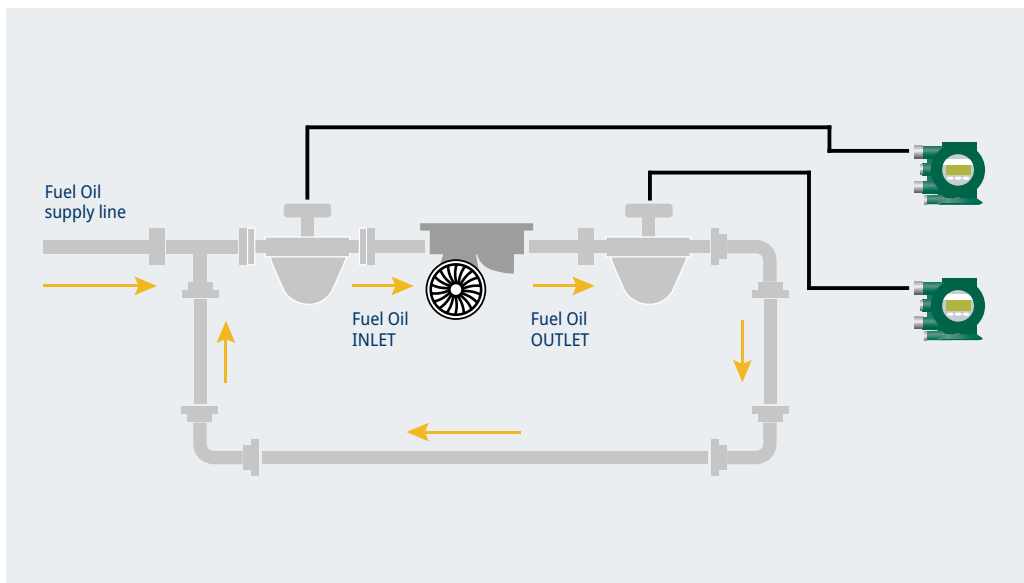

**Product Highlights**

- Many hazardous area approvals
- Full stainless-steel design
- Excellent mass flow accuracy
- DNV GL type approval



Rotamass Supreme



Rotamass Prime

# Flow measurement of complex & demanding fluids



Sensor measuring tube material or measurement accuracy can be affected by demanding and complex process fluids. The handling of such a fluid could be difficult and, in some cases, the process conditions need to be regulated very closely, so measurement needs to stay accurate under these conditions.

Corrosion resistant materials, insensitivity to harsh and changing process conditions, including multi-phase situation, as well as heating

continuity are main factors for the selection of a flowmeter for this kind of application. With its thick and resistant measuring tubes, combined with in-line meter verification with Tube Health Check predictive diagnostics, Rotamass TI will support your tasks in a reliable way in front of corrosive or clogging process situation.

Application examples are present in sectors like Chemical, Pharmaceutical or Oil and Gas industry.

## Offshore oil production

In offshore oil fields, Coriolis mass flowmeters have to measure fluids with fluctuating viscosities or with multiphases. At production wells those fluids can consist of a mixture of crude oil, water, gas and sand. As the gas content can fluctuate from 0 % to 100 % GVF, with high pressure fluctuation, a robust design combined with a performing sensor power management are required to ensure continuous and stable measurement.

### Product Highlights

- Gas content handling from 0 % to 100 % GVF
- High pressure rating
- Thick Hastelloy C measuring tubes against abrasion or sour gas
- Dynamic Pressure Compensation option

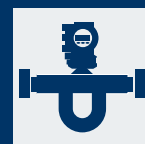

Rotamass Intense



Rotamass Giga

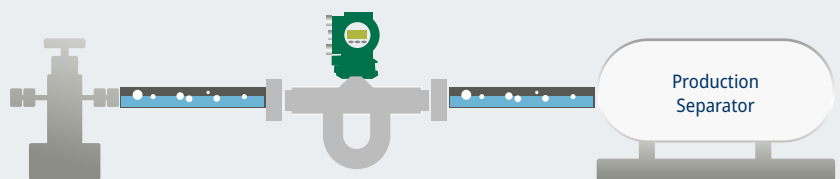

Crude oil, water and gas from the well head

Accurate measurement of mass and volume flow of crude emulsion into the process

Separation and further processing



### Molten sulfur processing

Sulfur is used in the Chemical and Pharmaceutical industry for production of e.g. acid sulfur, colorants or chemical fertilizer. Due to its viscosity and flammable properties, a continuous temperature regulation at around 145 °C is required to process this substance. A factory-fitted best in class insulation and heat tracing solution to handle fluids with temperature up to 350 °C qualifies Rotamass TI for this application.

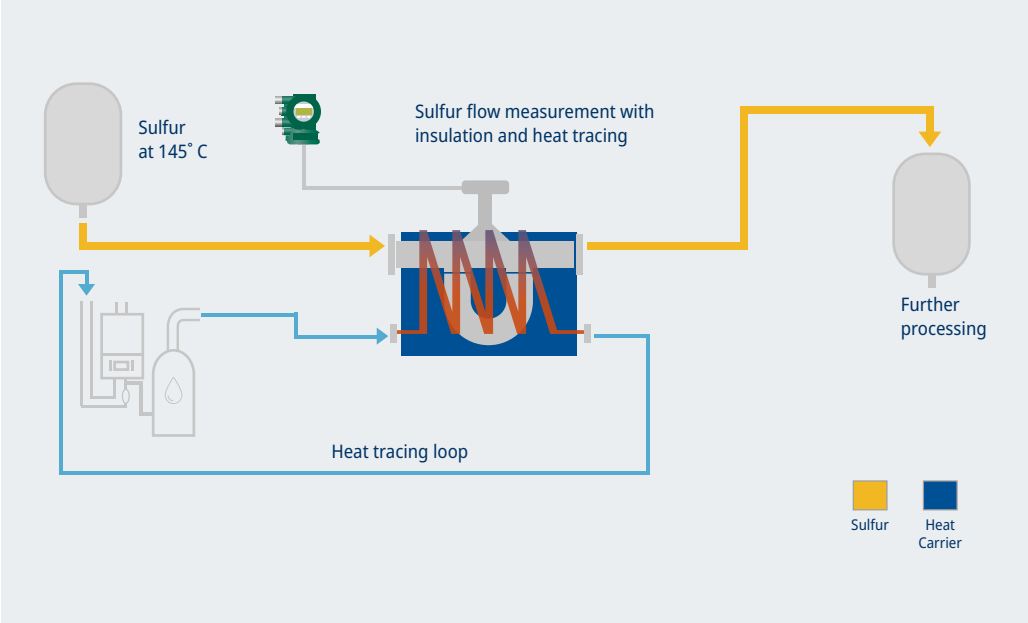

The diagram illustrates a molten sulfur processing system. It features a 'Sulfur at 145° C' tank on the left, connected to a central processing unit. A 'Sulfur flow measurement with insulation and heat tracing' device is installed on the line between the tank and the unit. A 'Heat tracing loop' is shown as a blue line with a pump, circulating heat carrier around the processing unit. The output line goes to a 'Further processing' tank. A legend indicates that yellow represents 'Sulfur' and blue represents 'Heat Carrier'.

**Product Highlights**

- Factory-fitted insulation and heat tracing
- In-line meter verification with Tube Health Check
- Designed for harsh process conditions



Rotamass Supreme



Rotamass Giga

### Processing material that causes deposition

Carbon is a component used for example for tires, colors and rubbers. Measuring carbon flow during processing flowmeters are faced with deposition in the measuring tubes. Therefore regular cleaning is required. Rotamass TI in combination with in-line Tube Health Check works perfectly for the definition of ideal cleaning cycle.

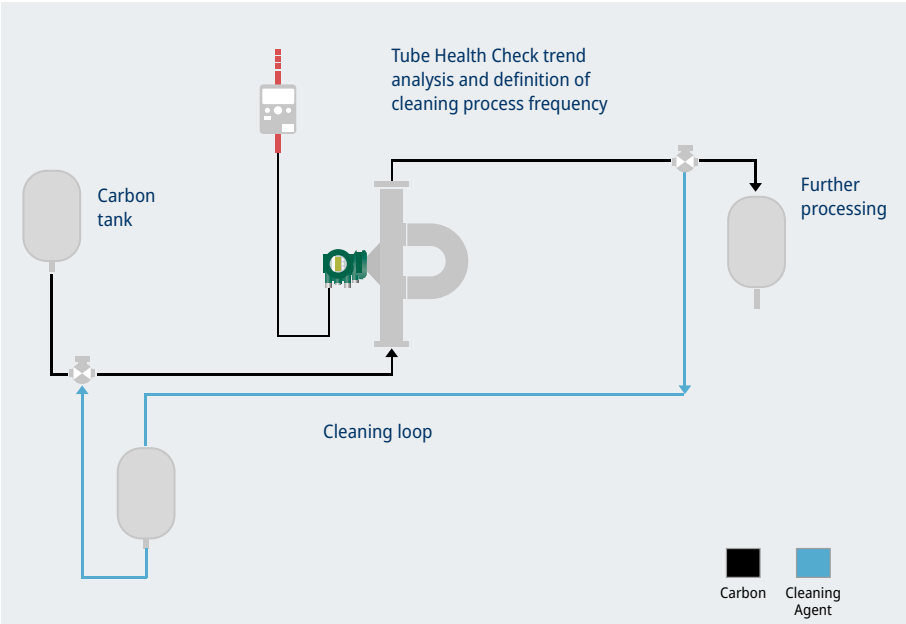

The diagram shows a carbon processing system. It includes a 'Carbon tank' on the left, a central processing unit, and a 'Further processing' tank on the right. A 'Cleaning loop' is depicted as a blue line with a pump, circulating a 'Cleaning Agent' through the system. A 'Tube Health Check trend analysis and definition of cleaning process frequency' device is connected to the main line. A legend indicates that black represents 'Carbon' and blue represents 'Cleaning Agent'.

**Product Highlights**

- Tube Health Check
- Event Management
- Thick measuring tubes



Rotamass Supreme



Rotamass Nano



Rotamass Prime

# Superior performance for dosing tasks



Filling, dosing or batching are widely spread tasks during the production of food, beverages, chemical products and many more.

Exact measurements, timing, continuous recording of results and possibilities for an easy adaption are expected in such processes.

With the help of Coriolis mass flowmeters, you can benefit from high resolution measurements that reduce batching errors and product losses.

Providing a dedicated Batching function, Rotamass TI is equipped to perform 1 or 2 stage batching operations, to detect and compensate valve closing time and "leakage", and is insensitive to the effects of fluid agitation, splashing, vibration.

## Chemical dosing

Pure chemicals can be quite aggressive, very expensive and even dangerous. In some cases, small amounts of these chemicals are feed into a carrier fluid. Here an exact dosing is decisive for the subsequent processing and the quality of the final product.

Rotamass TI offers high chemical resistance and precise flow measurement. With Tube Health Check a predictive maintenance is possible, especially when working with corrosive chemicals.

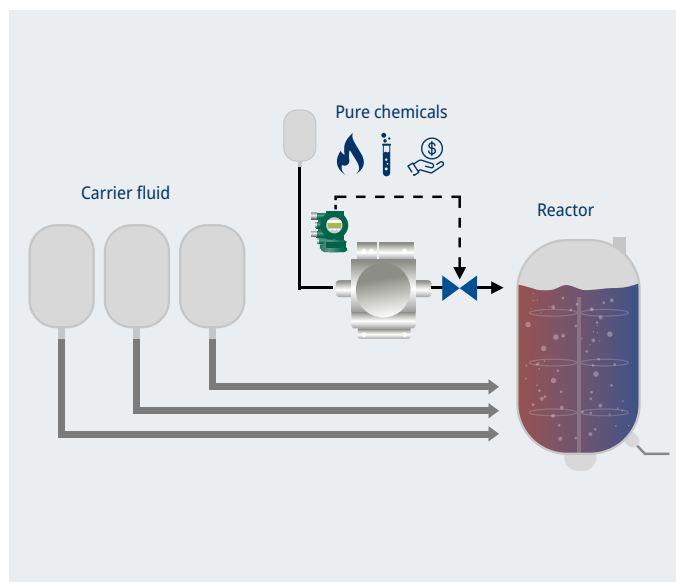

## Product Highlights

- Accuracy in mass and in volume
- Wetted parts Stainless steel or Hastelloy C
- Batch leakage detection and compensation
- Batch control by display or automatic

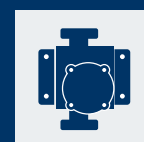

Rotamass  
Nano



Rotamass  
Supreme

### Batching in Food & Beverage processes

When producing food or beverages such as ice cream, soft drinks and many more, a Coriolis mass flowmeter is used to measure exactly the amount that is feed into a tank or reactor. The batching function controls a valve that starts and stops the filling process.

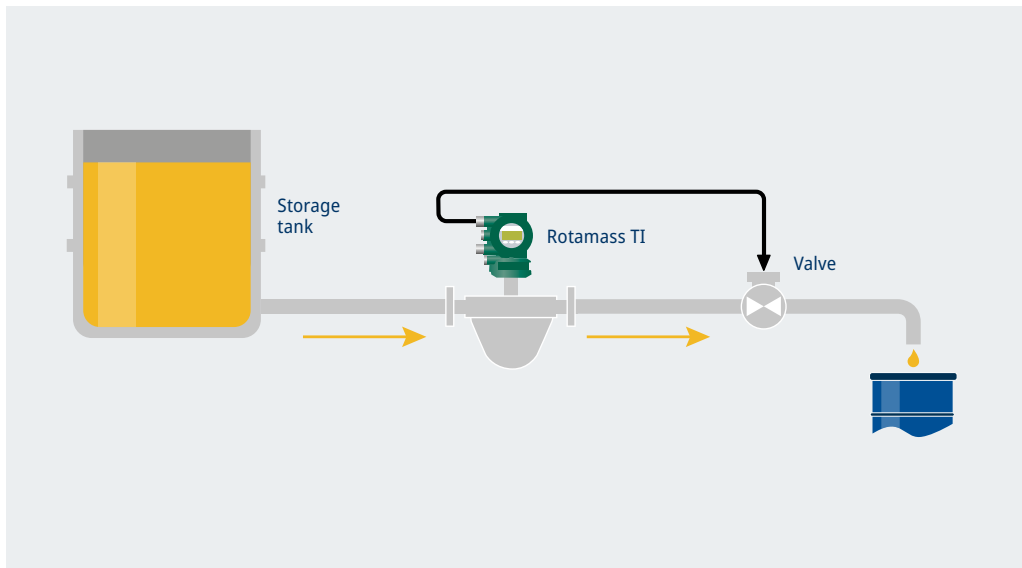

#### Product Highlights

- In-line CIP/SIP
- Self-draining
- 3-A or EHEDG
- 1-stage and 2-stage Batching function
- Sanitary clamp or thread process connection



Rotamass Hygienic



Rotamass Supreme

### Chemical injection upstream Oil & Gas

In the oil upstream production Coriolis mass flowmeter can be used to inject and dose accurately high-grade chemicals into production lines to prevent, among others, scaling (scale inhibitor) and foaming (defoamer). Rotamass TI provides accurate low flow measurements (in mass and in volume), and long-term stability even under high pressure conditions up to 460 bar.

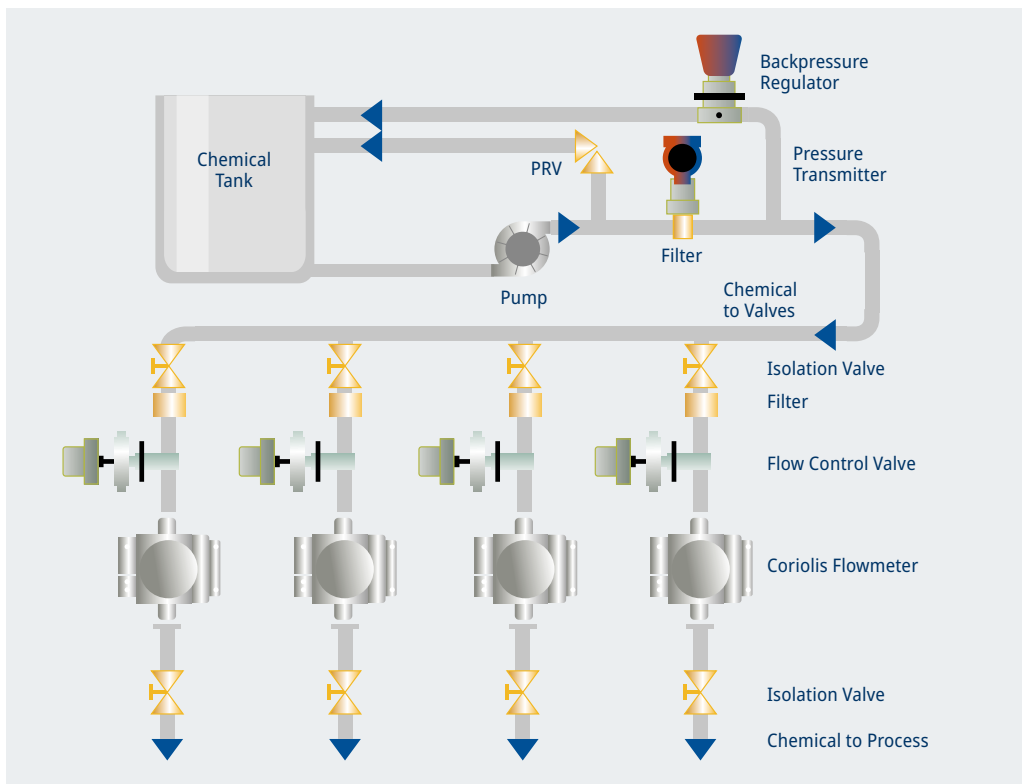

#### Product Highlights

- Precise injection with flat accuracy from 2.5 kg/h
- High pressure models
- Process connections from 1/4 in. (DN15)
- Advanced self-diagnostics
- Unlimited aeration handling capability

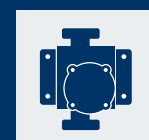

Rotamass Nano



Rotamass Intense

# Solutions for exact transfer and loading of products



Independent from industry type the unloading of raw materials, transfer of intermediates and loading of final goods requires precise flow measurement.

The fluids to be transported can show different grades, fluctuating density or entrained gas. In some applications even the type of fluid changes or the flow direction could be bidirectional.

With short installation length and capability to provide reliable results, although being installed directly after a pump, Rotamass TI is easy to install and reduces the maintenance effort.

Benefit from operational flexibility, superior accuracy and stable performance when using Rotamass TI in your transfer application, e.g. in the Food & Beverage, Oil & Gas or Marine industry.

## Production of fruit granulate

Fruit granulates are often used as component for cereals and other food products. The production starts with the crushing of frozen fruit pomace. During this first step the high-speed stirrer generates air into the pomace before the high viscous fluid is transferred to the next steps, heating, concentrating, freezing and sieving. Entrained air and high viscosity can be handled easily with Rotamass TI. The sensor is designed to generate low pressure loss and to fulfill the requirements for hygienic applications.

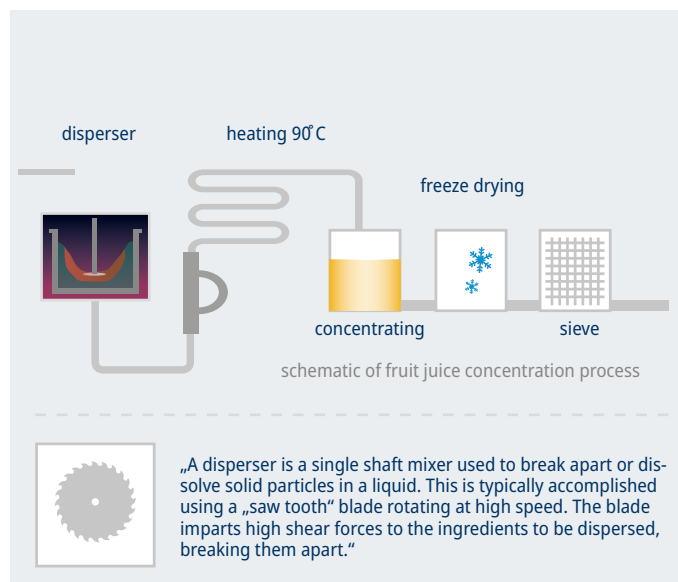

## Product Highlights

- Self-draining design
- 3-A and EHEDG approval
- Many hygienic process connections
- Low pressure loss design
- Handling entrained gas



Rotamass Hygienic



Rotamass Supreme



### Used oil refining

Used oil from car repair shops or industrial customers can be filtered and chemically treated. The result is a re-refined oil and is considered as renewable resource. It is sold to e.g. asphalt plants, industrial customers and municipal power plants for firing furnaces and boilers.

Unloading the delivery truck into the facilities holding tanks, the flowmeter faces a mixture of different oil grades and qualities. At the end of unloading process large air slugs can be present within the liquid. Rotamass TI is ideal for this application as it provides high accurate mass flow measurements, even dealing with viscosity changes, entrained gas, seasonal temperature fluctuations and pump vibrations.

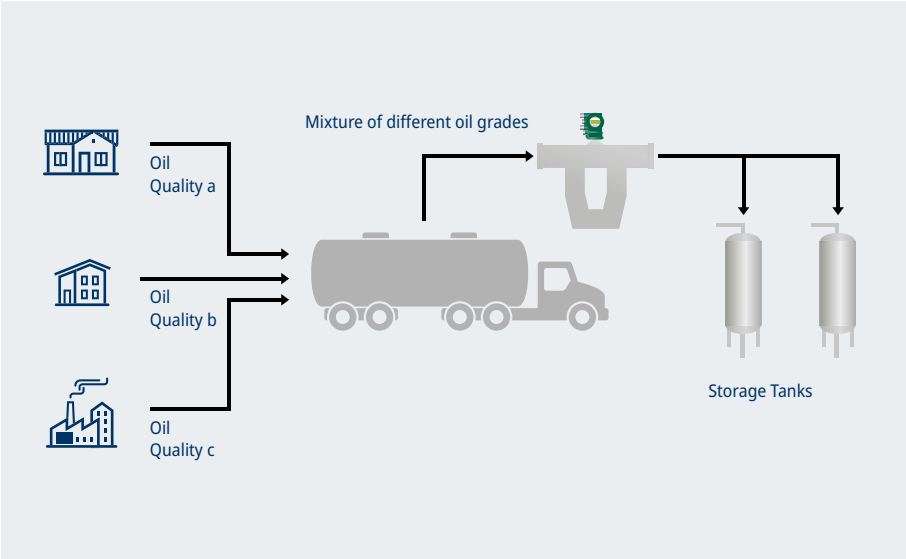

#### Product Highlights

- High accuracy
- Multi-measurement (Mass flow, temperature, density)
- Insensitivity to vibrations and changing conditions
- High Power Management for gas content detection and handling

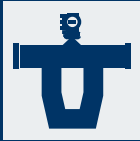
  
 Rotamass Giga

  
 Rotamass Supreme

  
 Rotamass Prime

### Product loading and unloading

High accuracy and reliability are important aspects when loading or unloading large amounts of a liquid or gas. Short loading time and exact record of the loaded product will contribute to efficiency targets.

Even under changing process conditions Rotamass TI will support this application with precise mass measurement, online monitoring of product density and its optimal excitation frequency to protect the complex cellular structures of the product.

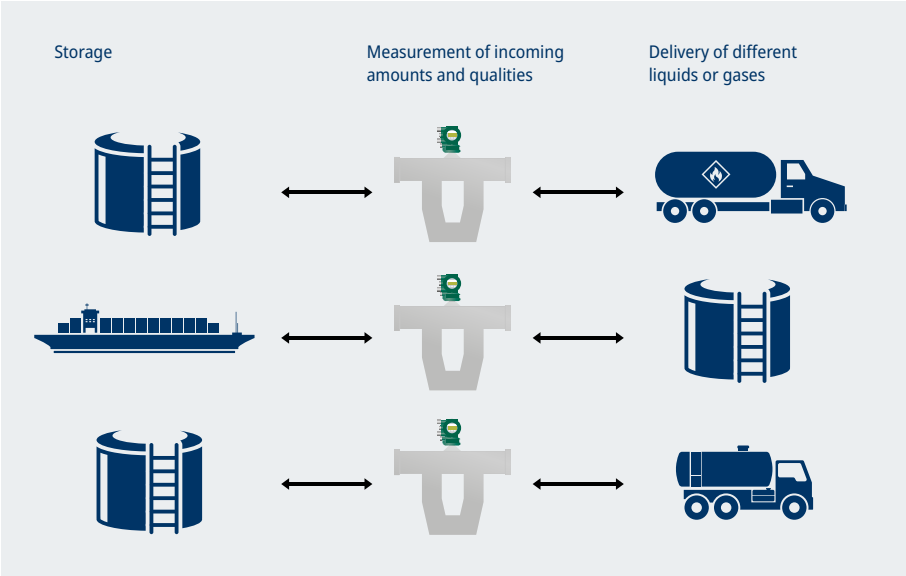

#### Product Highlights

- Robust design
- Data logging function
- Flow rate up to 600 t/h

  
 Rotamass Giga

  
 Rotamass Prime

  
 Rotamass Hygienic

# Calibration competence



During calibration process all our Coriolis mass flow-meters are compared directly to mass. The calibration is completely traceable to the primary kilogram.

Our calibration laboratory is accredited according DIN EN ISO/IEC 17025:2005, that specifies the general requirements for the competence to carry out tests and calibrations.

Calibration certificates issued by a laboratory accredited according EN 17025:2005 are accepted worldwide based on mutual recognition arrangements (MRA).

Each Rotamass TI is delivered with a standard calibration certificate with 4-points calibration, or optionally 5-points calibration, performed at reference calibration conditions.



 Water  (10-35) °C  (1-2) bar

Rotamass TI can be ordered with customer-specific 10-points calibration according to DAkkS, which can be used as reference for traceable measurements.

For gas measurement, the calibration is traceable according AGA report 11, API MPMS chapter 14.9.



**Capability of our certified laboratory: 2 kg/h up to 1200 t/h**

This is comparable to:  
2 waterdrops per second  
dropping from a water-tab up  
to filling 7 beer kegs per second



## Total Accuracy in real conditions

Coriolis Mass flowmeters are a synonym for highly accurate flow measurements. Specifications state mass flow accuracy of 0.2 %, 0.1 % or even 0.05 % of reading under reference calibration conditions, with pulse or digital outputs.

Therefore, to determine the Total Accuracy you have to take into account additional effects defined by the operating process conditions.

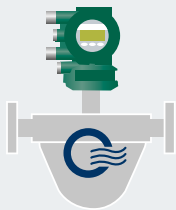

### Flow range validity

The mass flow accuracy is valid for a specified measuring range. For flowmeters you always need to consider zero stability effect in the specific low flow area. Rotamass TI has best in class zero stability and provides a wide turndown.

4 - 20 mA

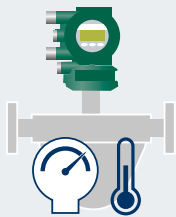

### Total Accuracy

Mass and mass flow measurement by Coriolis flowmeter are strongly independent from environmental changes. But precise accuracy of the flow measurement can be affected by process pressure and temperature changes due to thermal expansion of the measuring tubes. Process temperature effects are mostly compensated by the accurate temperature sensor of Rotamass TI. In case of fluctuating process line pressure, Rotamass TI offers Dynamic Pressure Compensation.

When 4 - 20 mA analog output is used, the additional digital/analog error effect and ambient temperature effect are minimized by state-of-the-art Yokogawa transmitter technology.

*ROTAMASS TI provides  
the best accuracy  
under real conditions.*

# ROTAMASS

Total Insight

ROTAMASS  
supreme



Superior performance under demanding conditions

ROTAMASS  
intense



For high pressure applications

ROTAMASS  
prime



Versatility with superior turndown and low pressure loss

ROTAMASS  
nano



For low flow applications

ROTAMASS  
hygienic



For food & beverage, biotechnology and pharmaceutical utility applications

ROTAMASS  
giga



Flexible installation for high flow applications

## Essential



for general purpose application

## Ultimate



for demanding & critical application

[www.rotamass.com](http://www.rotamass.com)



Synaptic  
Business  
Automation

Synaptic Business Automation creates sustainable value by connecting everything in our customers' organization. To realize this, Yokogawa integrates its business and domain knowledge with digital automation technologies, and co-innovates with customers to drive their business process transformation.

### YOKOGAWA ELECTRIC CORPORATION

World Headquarters, 9-32, Nakacho 2-chome, Musashino-shi, Tokyo 180-8750, Japan

<http://www.yokogawa.com/>

### YOKOGAWA EUROPE B.V.

Euroweg 2, 3825 HD Amersfoort, The Netherlands

<http://www.yokogawa.com/eu/>

### YOKOGAWA MIDDLE EAST & AFRICA B.S.C.(c)

P.O. Box 10070, Manama, Building 577, Road 2516, Busaiteen 225, Muharraq, Bahrain

<http://www.yokogawa.com/bh/>

### YOKOGAWA CHINA CO., LTD.

3F Tower D Cartelo Crocodile Building, No. 568 West Tianshan Road, Shanghai 200335, China

<http://www.yokogawa.com/cn/>

### YOKOGAWA ENGINEERING ASIA PTE. LTD.

5 Bedok South Road, Singapore 469270, Singapore

<http://www.yokogawa.com/sg/>

### YOKOGAWA CORPORATION OF AMERICA

2 Dart Road, Newnan, Georgia 30265, USA

<http://www.yokogawa.com/us/>

Represented by:

### Trademarks

All brand or product names of Yokogawa Electric Corporation in this brochure are trademarks or registered trademarks of Yokogawa Electric Corporation. All other company brand or product names are trademarks or registered trademarks of their respective holders.

Subject to change without notice

All Rights Reserved. Copyright © 2020, Rota Yokogawa GmbH & Co. KG

Printed in Germany, edition 03